



Siemens.com/mobility

QBCA1 Relay

A single wound dc biased ac immune contactor

General data

Contact Arrangement:	2HF 4B, 2HF 4F 4B 2HF 2F 4B, 2HF 2F 2B
Nominal Rated Voltage:	12V, 24V and 50V dc
Approximate Weight:	1.7 kg

Note: Refer to the following data sheets:

- 7-1-1 for general information and contact ratings.
- 7-2-1 for dimensions.
- 8.2 for tools.
- 8.3 for plugboard and connector details.

Refer overleaf for specific data.



B18558/1 Variant

Description

Originally designed to comply with BR specification 943. Other versions have since been added to the range.

The relay is identical to the QBA1 except that the four standard contacts in the 'C' stack are replaced by two heavy duty contacts and the four contacts in the 'B' stack are replaced by magnetic blowouts for the heavy duty contacts.

The rating of the heavy duty front (HF) contacts is specified as follows:

1. They must close the circuit to a dc or single phase a.c. 110 V point machine with a performance to BS581 and carry a current for a minimum of 10 seconds on a 50% dutycycle.
2. They must break a current of 30 amps in the foregoing conditions when the points are stalled a minimum of 500 times during the service life of the relay.
3. They must effectively open the circuit with a current of 100 amps dc and a circuit emf of 130 V but need not remain fully serviceable thereafter.
4. They must not weld when operated in a circuit of prospective current of not less than 200 amps and a circuit emf of 130 V dc

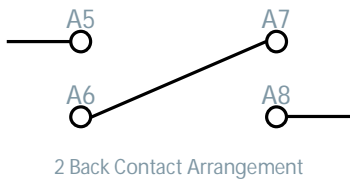
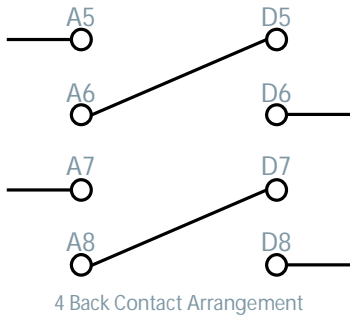

These arrangements can be used to give detection of a welded heavy duty contact.

Each heavy duty contact terminal is connected to two plugboard connectors in parallel, each connector should be wired with two wires in parallel to handle the heavy currents involved. To ensure efficient operation of the magnetic blowouts the connection polarity shown below must be observed for dc operation.

Other specific requirements for the relay are as follows:

1. The relay will operate when the positive is applied to R1 negative to R2.
2. The relay will not operate when up to 20 times normal working voltage is applied with the opposite polarity.
3. The application of up to 20 times normal voltage of either polarity must not change the characteristics of the relay by more than 10%.
4. The power consumption shall not exceed 3 W.
5. The application of up to 1000 V, 50 Hz shall not operate the relay.

All of the specified characteristics apply with a coil temperature of 20°C.

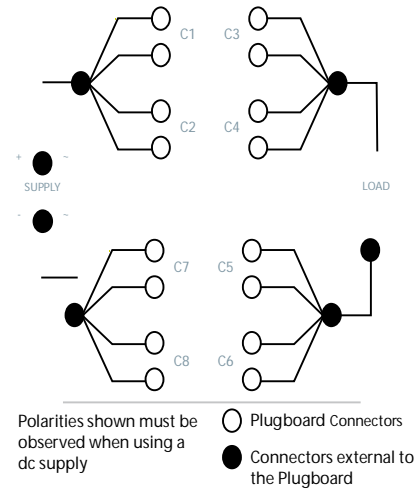

Contact layout viewed from rear

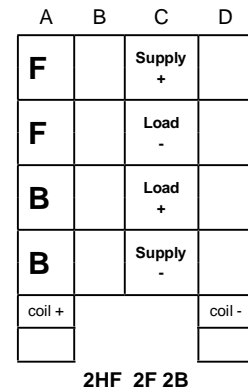
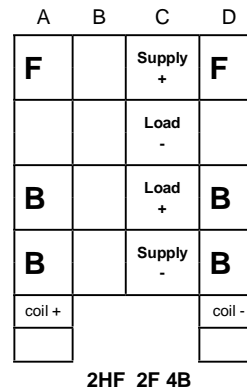
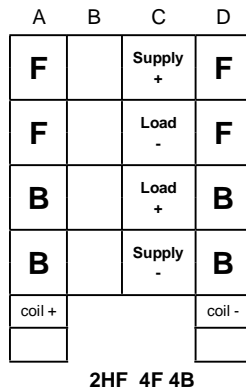
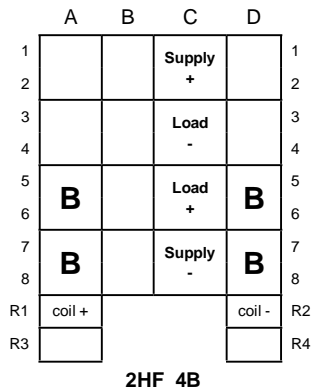

Packaging

Q-Relays are packed in a carton holding ten relays; the same container is used for quantities of four to nine relays. Quantities less than four are packed individually in cardboard boxes, as are all train-carried relays. Each container has a bar-coded label affixed to the outside, stating details of the packaged relay(s) and the quantity therein.

EMC Compliance

Q-Relays comply with the relevant emission requirements of EN 55014. It is considered that these relays have inherent immunity to in-service electro-magnetic disturbance. A Technical Certificate for EU Directive on EMC (89/336/EEC) has been obtained.

Technical data

SIEMENS Part No. (PAD No.)	CONTACT ARRANGEMENT	RATED VOLTAGE (V dc)	PIN CODE	COIL RES (OHMS)	WDG SPEC 1/108/-	MAX FULL OP. (V dc)	MIN REL (V dc)	PLUGBOARD	REQD No. OF CONNECTORS J4137/3	REMARKS
B18548/1 (085/001515)	2HF 4B	50	172 BCFHK	920	5	40	7.5	J4138/234	18	BRB Spec 943
B18548/2 (085/001505)	2HF 4B	24	170 BCEJK	208	6	19.2	3.6	J4138/240	18	BRB Spec 943
B18548/3	2HF 2F 4B	50	XBCEK	920	5	40	7.5	J4138/239	22	
B18548/4	2HF 2F 4B	24	XDEHJ	208	6	19.2	3.6	J4138/349	22	
B18548/5	2HF 2F 2B	12	ADHKS	150	177	9.6	1.8	J4138/403	18	
B18548/6	2HF 4F 4B	50	BEGHJ	940	188	40	7.5	J4138/465	26	M25068 Equivalent
B18548/7	2HF 4F 4B	24	BEFHJ	195	194	19.2	3.6	J4138/466	26	M25069 Equivalent
B18548/8	2 HF 4F 4B	12	ACBKS	55	192	9.6	1.8	J4138/435	26	M25070 Equivalent
B18548/9 (085/000961)	2 HF 2F 4B	24	170 BCEJK	208	6	19.2	3.6	J4138/240	22	BRB Spec 943



Un-drilled plugboard
Part No. E7218/1

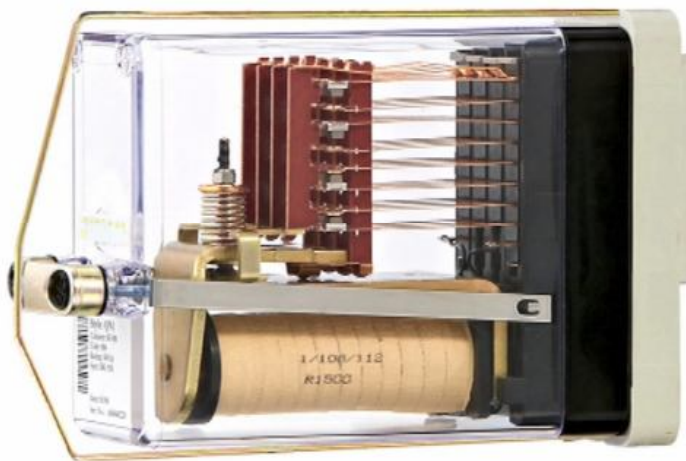

Representation of Relay,
Plugboard and Retaining clip
(Clip Part No. J4136/1)