

REV200.03RF  
REV200S.03RF

REV-R.03/1  
REV-R.03S/1

REV200RF/SET  
REV200SRF/SET

## Room Temperature Controller

## REV200../SET

Backlit touch screen with integrated radio transmitter and receiver  
(switching unit with relay outputs)

- Mains-independent room temperature controller
- Easy-to-understand, self-explanatory touch screen
- Self-learning 2-position controller with PID control (patented)
- Choice of 3 different 24-hour operating modes and one 7-day mode including individually adjustable 24-hour modes
- Control of cooling equipment
- Advantageous for retrofitting and upgrading projects (wireless room unit)

### Use

Room temperature control in:

- apartments, single-family or holiday houses
- offices, individual rooms and consulting rooms or commercially used spaces

For the control of the following pieces of equipment:

- Solenoid valves of an instantaneous water heater
- Solenoid valves of an atmospheric gas burner
- Forced draft gas and oil burners
- Heating pumps, zone valves (normally closed)
- Electric direct heating systems or fans of an electric storage heater
- Thermic actuators
- Cooling and refrigeration equipment

## Functions

---

- Radio signal transmission
- PID control with a self-learning or selectable switching cycle
- Automatic operation with 7-day program
- 3 different 24-hour modes
- Remote control and override button
- Sensor calibration, reset function
- Locking of display to facilitate cleaning and to prevent tampering
- Frost protection function, minimum limitation of the setpoint
- Holiday mode
- Cooling
- Pump kick
- Optimum start for the first heating period (P.1)

## Type summary

---

### Radio signal equipment consisting of:

Room temperature controller (transmitter), receiver (switching unit) and support	REV200RF/SET REV200SRF/SET
Room temperature controller (transmitter) and support	REV200.03RF REV200S.03RF
Receiver (switching unit)	REV-R.03/1 REV-R.03S/1

## Ordering

---

Room temperature controller with 7-day program	REV200RF/SET REV200SRF/SET
When ordering, please give type reference according to "Type summary". The unit is supplied complete with batteries.	

## Technical features

---

<b>Control</b>	The REV200... is a 2-position controller providing PID mode. The room temperature is controlled by the cyclic switching of a regulating unit. The control generates the positioning signals according to the deviation of the adjusted setpoint from the actual value acquired by the built-in temperature sensing element. The rate of response of the plant depends on the selected control algorithm:
Self-learning mode	The factory settings produce a self-learning operating mode. The controller adapts automatically to the type of controlled system (that is, type of building construction, heat demand, types of radiators, size of rooms, etc.). After a certain learning period, the controller optimizes its parameters and then operates in the mode it has learned.
Control algorithm	In exceptional cases where the self-learning mode may not be adequate, it is possible to select PID 12, PID 6 or 2-Pt mode:  PID 12 mode    Switching cycle of 12 minutes for normal or slow controlled systems (e.g. massive building structures, large spaces, cast-iron radiators, oil burners).  PID 6 mode     Switching cycle of 6 minutes for fast controlled systems (e.g. light building structures, small spaces, plate radiators or convectors, gas burners).

2-Pt mode Pure 2-position control with a switching differential of 0.5 °C ( $\pm 0.25$  °C) for very difficult controlled systems with considerable outside temperature variations.

**Parameter settings**

The control algorithm is selected with DIP switches no. 1 and no. 2. All basic settings are made with a number of DIP switches. The DIP switches can be accessed by removing the unit from its base.

Every DIP switch setting must be confirmed by pressing the DIP switch button, thus activating the setting.

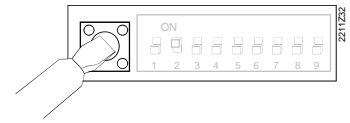

Function	Switch no.								
	1	2	3	4	5	6	7	8	9
Self-learning control *	▼	▼							
PID mode with a switching cycle of 12 minutes	▼	▲							
PID mode with a switching cycle of 6 minutes	▲	▼							
2-position control	▲	▲							
Setpoint limitation 3...29 °C *			▼						
Setpoint limitation 16...29 °C			▲						
Heating active				▼					
Cooling active				▲					
Periodic pump run OFF *					▼				
Periodic pump run ON					▲				
Optimum start control OFF *						▼	▼	▼	
Optimum start control ¼ h / °C						▼	▼	▲	
Optimum start control ½ h / °C						▼	▲	▼	
Optimum start control 1 h / °C						▲	▼	▼	
Sensor calibration inactive *									▼
Sensor calibration active									▲

\* Default settings (all OFF)

**Operating modes**

The controller has 4 different automatic modes with a choice of 24-hour and 7-day programs.	
In addition, 2 continuous modes without a switching program function and one standby mode are available.	

**Switching program**

By selecting the appropriate operating mode, the switching program can be used either as a 7-day or 24-hour program. In addition, it is possible to select a continuous operating mode, which does not make use of the switching program.

**24-hour program**

For the 24-hour program, there are 3 different switching patterns available. There is a choice of 1, 2 or 3 switching cycles. Depending on the choice made, this switching pattern is then repeated for every day.

At the switching points, both the time and the associated setpoint can be selected. A specific setpoint can be selected for each switching point.

Example with 2 switching cycles:

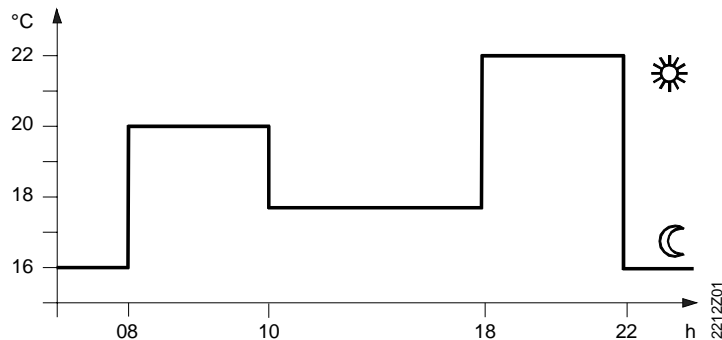

7-day program

The 7-day program offers different switching patterns for every day of the week. This means that one of the three 24-hour switching patterns can be selected differently for every day of the week, depending on the requirements. Like with the 24-hour program, time and setpoint of every switching point can be different.

Override button

In the automatic modes, a manual change from normal to economy temperature can be enforced via the override button. The selection will automatically be reset when the next switching point is reached or when changing the operating mode.

**Sensor calibration**

If the temperature displayed does not agree with the room temperature effectively measured, the temperature sensor can be recalibrated. Calibration is activated with DIP switch no. 9 (sensor calibration ON) and a DIP switch reset. The displayed room temperature can be brought in line with the room temperature effectively measured, the increments being 0.2 °C (max. ±2 °C).

Important

When sensor calibration is completed, the DIP switch must be reset to OFF and the DIP switch reset button must be pressed.

**Optimum start control**

Switch-on point P.1, which is the first switch-on point of the day, is brought forward such that the selected setpoint will be reached at the desired time. The setting depends on the type of control system in use, that is, on heat transmission (piping system, radiators), building dynamics (building mass, type of insulation), and heating output (boiler capacity, flow temperature). Optimization can be set with DIP switches no. 6, 7 and 8.

<b>OFF</b>	No effect
<b>¼ h / °C</b>	For fast controlled systems
<b>½ h / °C</b>	For medium controlled systems
<b>1 h / °C</b>	For slow controlled systems

Example with an actual room temperature of 18 °C and a setpoint of 20 °C:

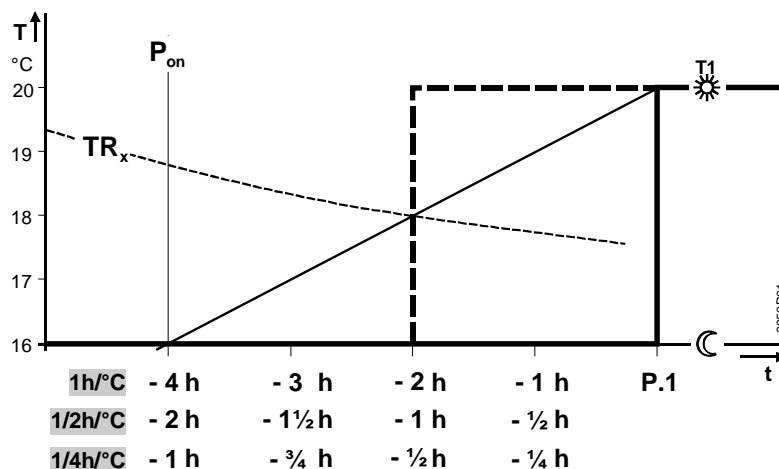

t	Temperature (°C)	TRx	Actual value of the room temperature
t	Forward shift of switch-on point (h)	P <sub>on</sub>	Starting point optimum start control

<b>Cooling</b>	DIP switch no. 4 is used for switching over to cooling mode when used in cooling applications.
<b>Periodic pump run</b>	The setting is made with DIP switch no. 5 while the pump is running. This protects the pump against seizure during longer OFF periods. Periodic pump run is activated for one minute every 24 hours at 12:00 h.
<b>Setpoints</b>	In the automatic modes, the setpoints can be entered for every switching point, and individually in the continuous modes.
Limitation of setpoint	When using minimum limitation of the setpoint to 16 °C, undesired heat transfer to neighbouring flats is prevented in buildings that have several heating zones. The function can be selected with DIP switch no. 3.
<b>Reset</b>	<p>Keep the button behind the little hole depressed for at least 3 seconds. This resets the individual settings and the time of day to their default values. During the reset time of 3 seconds, the display will be fully lit, allowing the correct functioning of the display to be checked.</p> <p>After each reset, all personal settings such as time of day, weekday, switching points, temperature setpoints, holidays, sensor calibration, etc., must be reentered.</p>
<b>Holiday function</b>	For the holiday function, the start day (maximum 6 days in advance), the duration of the holiday period and the temperature setpoint must be entered. This means that when absent for a longer period of time (up to 99 days), the plant can be switched to the required economy temperature starting on the day of departure. Every midnight, the counter subtracts one day. When the day counter returns to 00, the operating mode selected last will automatically be resumed.

## **Mechanical design**

---

<b>Controller</b>	<p>Plastic housing with a large display which also serves as a touch screen. The display's lighting is switched on by touching the screen and switches automatically off after 15 seconds.</p> <p>The controller (top section) can be easily removed from its base by pressing a button. A hinged battery compartment cover facilitates the straightforward exchange of the two 1.5 V alkaline batteries type AA. The base can be fitted to all commercially available recessed conduit boxes or directly on the wall and can then be wired before fitting the controller to it. The housing accommodates the electronics, a <b>DIP</b> switch and a relay with a potential-free changeover contact. The connection terminals are integrated in the base.</p>
-------------------	---

## Display and operating elements

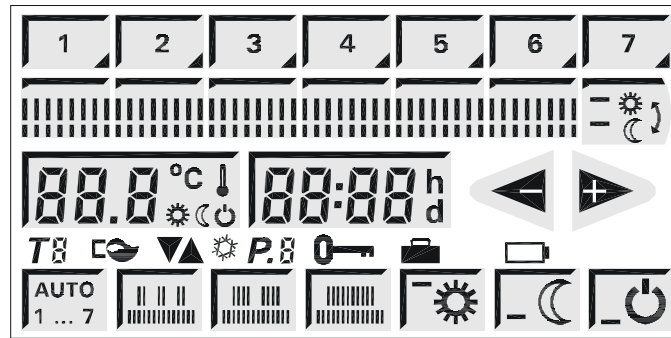

Display check

### Button displays



### Temperature values and symbols



Normal temperature



Economy temperature



Standby with frost protection



Time of day or switching time

### Display symbols



Change batteries



Bumer in operation



Locking of display active



Holiday program active



Temperature setpoint number of switching program



Display button (with display of the current day)



Cooling function activated



Switching point number of switching program

### Arrow buttons

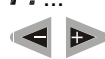

Increasing / decreasing values

### Operating mode buttons



Automatic operation for the 7-day program with up to 3 heating periods per day



Automatic operation for the 24-hour program with 3 heating periods



Automatic operation for the 24-hour program with 2 heating periods



Automatic operation for the 24-hour program with 1 heating period



Continuous operation with the normal temperature



Continuous operation with the economy temperature



Standby with frost protection

### Switching time buttons



Switching time buttons for setting the switching points

### Level button / override button



For switching manually from the normal to the economy temperature, and vice versa



### Display locking / reset



Opening for locking the display or for the reset

## Display button function

The entire operation is effected via the touch screen. For this purpose, the screen is divided into sections that provide display and button functions. This is indicated by highlighting. If a field is highlighted, it has button functions; if a field is not highlighted, it is used for display purposes. When a field is selected by touching, a black pointer appears and the current value flashes, which can then be changed by touching the + / - buttons.

Automatic storage	When an adjustable display button is touched, the displayed value will automatically be stored 5 seconds later and the display returns to the initial operating mode. The same action is achieved when touching the button again.
Adjusting the values	 Pressing one of these buttons for less than one second produces a step of one minute (time settings) or of 0.2 °C (temperature settings). Pressing for more than one second means quick adjustment which can be cancelled again by pressing the button repeatedly.
<b>Locking the display</b>	Before cleaning the display or to prevent tampering, the display buttons can be locked.
Activation	Press the button behind the little hole for a short moment (max. 1 second):  appears and all other displays disappear. The display buttons are now disabled while all the other functions are fully maintained.
Deactivation	Press the button behind the little hole again (max. 1 second).
“TEST” and “LEARN” buttons	Press test button <b>T</b> (rear of device) for 4 seconds to test the connection to the receiver via telegram. Pressing the learning button <b>L</b> for 4 seconds transmits the corresponding receiver address.
<b>Battery change</b>	About 3 months before the batteries are exhausted, the display shows the battery symbol  . The other displays disappear, the display buttons are deactivated while all the other functions are fully maintained. When changing the batteries, the current data will remain stored for at least one minute.
<b>Receiver REV-R...</b>	Plastic housing with easily accessible operating elements and removable cover. The unit can be fitted to all commercially available recessed conduit boxes or directly on the wall. A relay with a potential free changeover contact, the connection terminals and the receiving antenna are integrated in the housing.
<b>Base</b>	The base can be fitted to most types of commercially available recessed conduit boxes or directly on the wall.
<b>Support</b>	The support supplied with the controller enables the unit to be put on a shelf. It can be easily fitted to the controller with no need for tools.

## Notes

---

### Planning controller / transmitter REV200...

- The room unit should be located in the main living room (on the wall or free-standing using the support provided) while giving consideration to the following points:
- The distance to the receiver should not exceed 20 m or 2 floors
- The unit should be located such that the sensor is able to capture the room temperature as accurately as possible, without getting affected by direct solar radiation or other heat or refrigeration sources (in the case of wall mounting, about 1.5 m above the floor)
- The unit should be located such that it can transmit signals with as little interference as possible. For this reason, the following points should be observed:
  - Do not mount the unit on metal surfaces
  - Not in the vicinity of electrical cables and equipment such as PCs, TV sets, microwave appliances, etc.
  - Not in the vicinity of large metal structures or construction elements with fine metal meshes like special glass or special concrete
- The control mode can be changed with the DIP switch located at the rear of the unit.

- If the room temperature displayed does not agree with the room temperature effectively measured, the temperature sensor should be recalibrated (refer to « Sensors Calibration » page 4).

**Wall mounting of controller / transmitter**  
**REV200.03RF**  
**REV200S.03RF**

- The unit can be fitted to most commercially available recessed conduit boxes or directly on the wall
- Mounting height is approximately 1.5 m above the floor
- When installing the controller, the base must first be fitted. Then, the unit can be engaged at the top, swung downward and snapped on
- For more detailed information, refer to the installation instructions supplied with the unit
- In the case of wall mounting, ensure that there is sufficient clearance for removing the controller from its base, and for replacing it

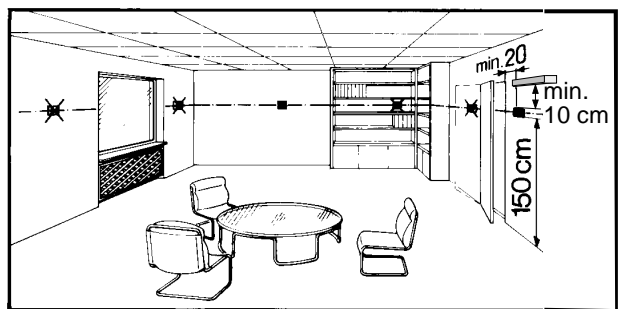

**Support of REV200...**

- Refer to the Installation Instructions printed on the package.

**Planning Receiver**  
**REV-R.03/1**  
**REV-R.03S/1**

- The receiver and switching unit should preferably be mounted near the controlled device
- The unit should be located such that it can receive signals with as little interference as possible. For this reason, the following points should be observed (same as with the transmitter):
  - Not in control panels
  - Not on metal surfaces
  - Not in the vicinity of electrical cables and equipment such as PCs, TV sets, microwave appliances, etc.
  - Not in the vicinity of large metal structures or construction elements with fine metal meshes like special glass or special concrete
- The location where the unit is mounted should be dry and free from splash water
- The unit can be fitted to most commercially available recessed conduit boxes or directly on the wall

**Mounting and installation of receiver**  
**REV-R.03/1**  
**REV-R.03S/1**



The receiver must be wired with the power supply switched off. Mains voltage may be switched on again only after the unit is completely mounted.

- When mounting the unit, the base must first be fitted and wired (L/N = AC 230 V mains supply, LX/L1 = consumers). Then, engage the unit at the top, swing it downward and secure it with a screw
- For more detailed information, refer to the Installation Instructions supplied with the unit

For the electrical installation, the local safety regulations must be complied with.



**Commissioning  
controller/transmitter  
REV200...  
and receiver  
REV-R.03/1  
REV-R.03S/1**



**1. Switch on  
REV200...**

- Remove the battery transit tab: As soon as the battery transit tab is removed, the unit starts to operate.

**2. Mount REV-R.03/1  
REV-R.03S/1  
temporarily**

- If possible, mount receiver temporarily in a first run (e.g. double coated tape). Doing that, location of best RF reception can be identified later on. See clause "5 Find location of best reception"
- Completely wire and mount REV-R... temporarily (please also close front cover)

**3. Link REV-R...  
with REV200...**

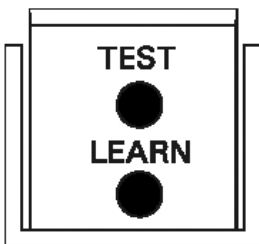

- Switch on power at REV-R...: LED\_1 lights always in red or flashes in red
- Press the "RESET" button on REV-R... for about 4 seconds: The orange LED\_2 will flash very fast and briefly (stored address of REV200... will be erased)
- Press the "SET" button on REV-R... (set / learn) for about 3 sec. until the orange LED\_2 starts flashing slowly and continuously: Receiver is now in learning mode
- The REV-R... stays max. 25 minutes in learning mode. If no learning telegram from REV200... is received during that period of time, repeat steps b) and c) again
- Press the "LEARN" button on REV200... for about 4 seconds. Learning telegram is transmitted
- If REV-R... receives learning telegram, the orange LED\_2 flashes fast and briefly
- If the orange LED\_2 is steady on, the relay is energized (= controlled device ON)
- If the orange LED\_2 is dark, the relay is deenergized (= controlled device OFF)
- Depending on the operating state, REV200... repeats the ON or OFF control telegram every 3 minutes. With this the relay will be switched ON or OFF according to control telegram latest after 3 minutes
- If REV-R... does not receive any correct control telegram within 60 minutes from REV200..., controlled device is being switched off and LED\_1 flashes in red
- In the event of a power failure at the REV-R..., the relay will be deenergized.

**4. Site REV200...**

- Site REV200... at preferred location for mounting at wall or setting up with stand
- Also refer to "Mounting and siting notes REV200... and REV-R..."



**5. Find location of  
best RF reception**

- Switch off power at REV-R...
- Switch on REV200..., site at preferred location and press the "TEST" button for about 4 seconds: REV200... transmits test telegrams every 2 seconds. Transmission of test telegrams stops automatically after 10 minutes or after pressing "TEST" button.
- Switch on power at REV-R...
- Observe both LEDs on REV-R... from a distance of 2...3 meters
- Orange LED\_2 must flash briefly every 2 seconds. If LED\_2 does not flash every 2 seconds, distance between REV200... and REV-R... is too far. Mount REV-R... closer to REV200...
- LED\_1 shows received signal strength of last telegram:  
LED\_1 flashes red: Signal is too weak to get a durable link. Mount REV-R... closer to REV200...

LED\_1 flashes green: We distinguish between three signal strengths:  
 Very good (flashes 3x), Good (flashes 2x) and  
 Satisfactory (flashes 1x).  
 As soon as LED\_1 flashes in green, link between  
 REV200...and REV-R... is basically ok.

- g) Move REV-R... within an area of approximately 1 square meter to find location of best RF reception. Always observe LEDs from a distance of 2...3 meters. To get a durable link, we recommend to site REV-R... at a location where signal strength is at least "Good".

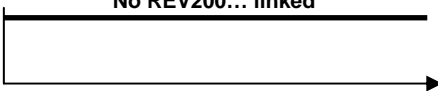
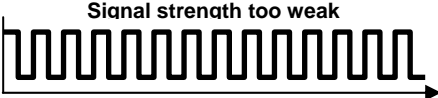
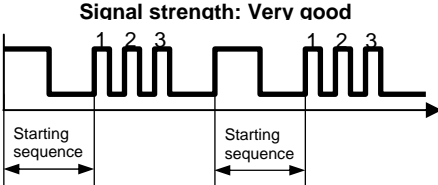
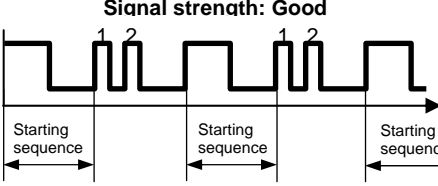
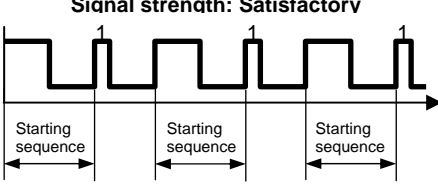
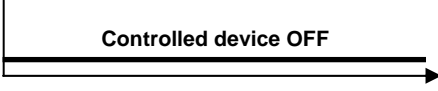
## 6. Explanations to LEDs

LED_1 lights always in red	Red on Red off	
LED_1 flashes in red	Red on Red off	
LED_1 flashes 3 times in green	Green on Green off	
LED_1 flashes 2 times in green	Green on Green off	
LED_1 flashes 1 time in green	Green on Green off	
LED_2 is always off	Orange on Orange off	
LED_2 is always on	Orange on Orange off	
LED_2 flashes always	Orange on Orange off	
LED_2 flashes briefly	Reption of control telegram	



## 7. Finishing mounting of REV-R...

- a) Switch off power
- b) Mark location where REV-R... is currently fixed
- c) If necessary loosen wiring
- d) Mount receiver at location marked before, wire completely and close housing
- e) Switch on mains power

### Notes

- In the event of a power failure at the REV-R..., the relay will be deenergized.
- If in normal operation REV-R... does receive for more than 25 minutes a very weak or no control telegram from REV200..., LED\_1 starts to flash in red. If control telegram is still understood correctly, receiver continues with normal operation. If control telegram is not understood anymore, relay remains in last position being switched to before. As soon as REV-R... does receive any correct control telegram from REV200... again, receiver continuous with normal operation
- In case of error, REV-R... switches off relay approximately 60 minutes after reception of last correct control telegram. The controlled device is also switched off and LED\_1 flashes in red. As soon as REV-R... does receive any correct control telegram from REV200... again, receiver continuous with normal operation

## Technical data REV200...RF

General unit data	Operating voltage	DC 3 V
	Batteries (alkaline AA) 2 x 1.5 V	2 x 1.5 V
	Life	approx. 2 years
	Backup for battery change	max. 1 min
	Switching capacity of relay	
	Voltage	AC 24...250 V
	Current	8 (3.5) A
	Sensing element	NTC 50 k $\Omega$ $\pm$ 2 % at 25 °C
	Measurement range	0...40 °C
	Time constant	max. 10 min
	Setpoint setting ranges	
	Normal temperature	3...29 °C
	Economy temperature	3...29 °C
	Frost protection temperature	3...16 °C
	Resolutions of settings and displays	
Setpoints	0.2 °C	
Switching times	10 min	
Measurement of actual value	0.1 °C	
Display of actual value	0.2 °C	
Display of time	1 min	
General data transmitter	SRD band	868.7 to 869.2 MHz
	Transmit frequency REV200...RF	868.95 MHz
	Max. transmitter power	< 10 mW / typically 4 mW
	Max. data throughput	19200 symbol/s = 38400 Bit/s
	Modulation	binary frequency changeover BFSK
	Frequency stability	< $\pm$ 20 ppm ( $\pm$ 17 kHz)
Standards	Address range (preset in the factory)	16 Bit (0...65535)
	 conformity	
	Electromagnetic compatibility	89/336/EEC
	Low voltage directive	2006/95/EEC
	R&TTE directive	EN 301 489-3
	Product safety	
	Radio equipment	EN 301 489-3
	EMC directive	
	Electromagnetic immunity	EN 61000-6-2
	Electromagnetic emissions	EN 61000-6-3
	Radio equipment	EN 300 220-3
	Approvals	 0359 
	In the following countries	All ECC countries, Norway, Iceland and Switzerland
	Safety class	II to EN 60 730-1
	Degree of protection	IP30 to EN 60 529
Environmental conditions	Perm. ambient temperature	
	Operation	3...35 °C
	Storage and transport	-25...+60 °C
Weight	Perm. ambient humidity	G to DIN 40 040
	REV200.03RF incl. packing	0,42 kg
	REV200RF/SET incl. packing	0,74 kg
Color	Housing REV200.03RF	signal-white RAL9003
	Base REV200.03RF	grey RAL7038
	Housing and base REV200S.03RF	silver RAL 9006
Seize	Housing	130 x 110 x 33 mm

## Technical data receiver REV-R...

<b>General unit data</b>	Operating voltage	AC 230 V +10/-15 %	
	Power	< 10 VA	
	Frequency	45...65 Hz	
	Switching capacity of relays		
	Voltage	AC 24...250 V	
	Current	6 (2.5) A	
<b>Environmental conditions</b>	Operation	to IEC 60 721-3	
	Climatic conditions	class 3K3	
	Temperature	0...+45 °C	
	Humidity	<85 % r. h.	
	Storage and transport	to IEC 60 721-3	
	Climatic conditions	class 2K3	
	Temperature	-25...+70 °C	
	Humidity	<93 % r. h.	
	Mechanical conditions	class 2M2	
<b>Norms and standards</b>	<b>CE</b> conformity		
	EMC directives	89/336/EEC	
	Low-voltage directives	2006/95/EEC	
	R&TTE directives	EN 301 489-3	
	Product safety		
	Radio equipment	EN 301 489-3	
	Automatic electrical controls for household and similar use	EN 60 730-1	
	Special requirements placed on energy controllers	EN 60 730-2-11	
	Electromagnetic compatibility		
	Immunity	EN 61 000-6-1	
	Emissions	EN 61 000-6-3	
	Radio equipment	EN 300 220-3	
	Approval	<b>CE</b> 0359 ⓘ	
	In the following countries	all ECC countries, Norway, Iceland and Switzerland	
	Devices of safety class	II to EN 60 730-1	
	Degree of pollution	normal	
	Weight (incl. package)		
		REV-R.03/1	0.27 kg
		REV200RF/SET	0.74 kg
	Color REV-R.03/1		
Unit front		Signal-white RAL 9003	
Base		grey RAL 7038	
Color REV-R.03S/1		Front and base silver RAL 9600	
Dimensions		83x104x32 mm	

## Connection diagram receiver REV-R...

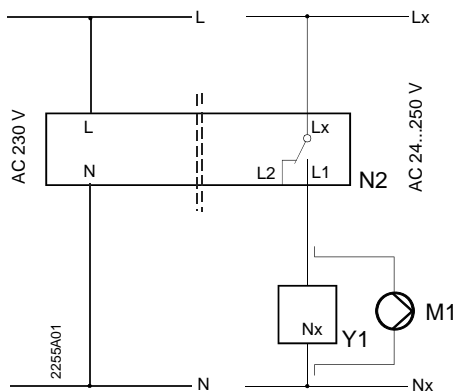

- L Live conductor, AC 230 V
- N Neutral conductor, AC 230 V
- Lx Live, AC 24...250 V
- L1 N.O. contact, AC 24...250 V / 6 (2.5) A
- L2 N.C. contact, AC 24...250 V / 6 (2.5) A
- M1 Circulating pump
- N2 Receiver REV-R...
- Y1 Actuating device

## Application examples

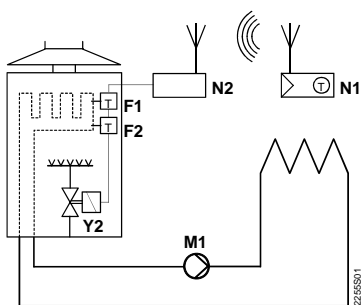

Instantaneous hot water heater

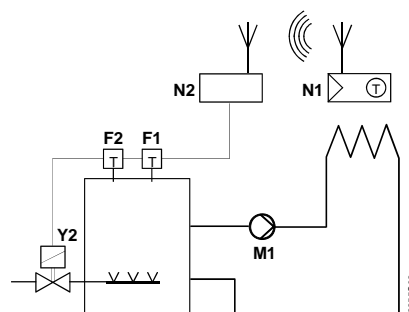

Atmospheric gas burner

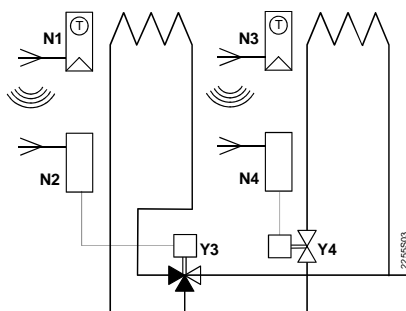

Zone valve

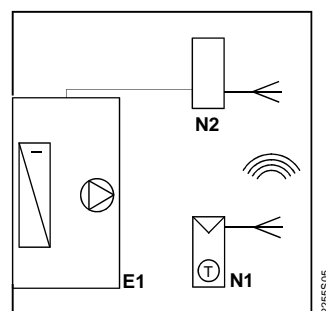

Cooling equipment

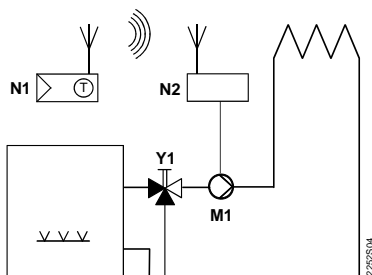

Circulating pump with precontrol by manual mixing valve

- E1 Cooling unit
- F1 Thermal reset limit thermostat
- F2 Safety limit thermostat
- M1 Circulating pump
- N1 Room temperature controller (transmitter) REV200...RF
- N2 Receiver REV-R...
- N3 Room temperature controller (transmitter) REV200...RF
- N4 Receiver REV-R...
- Y1 3-port valve with manual adjustment
- Y2 Solenoid valve
- Y3 Motorized 3-port valve
- Y4 Motorized 2-port valve

Dimensions

Controller / transmitter REV200...RF

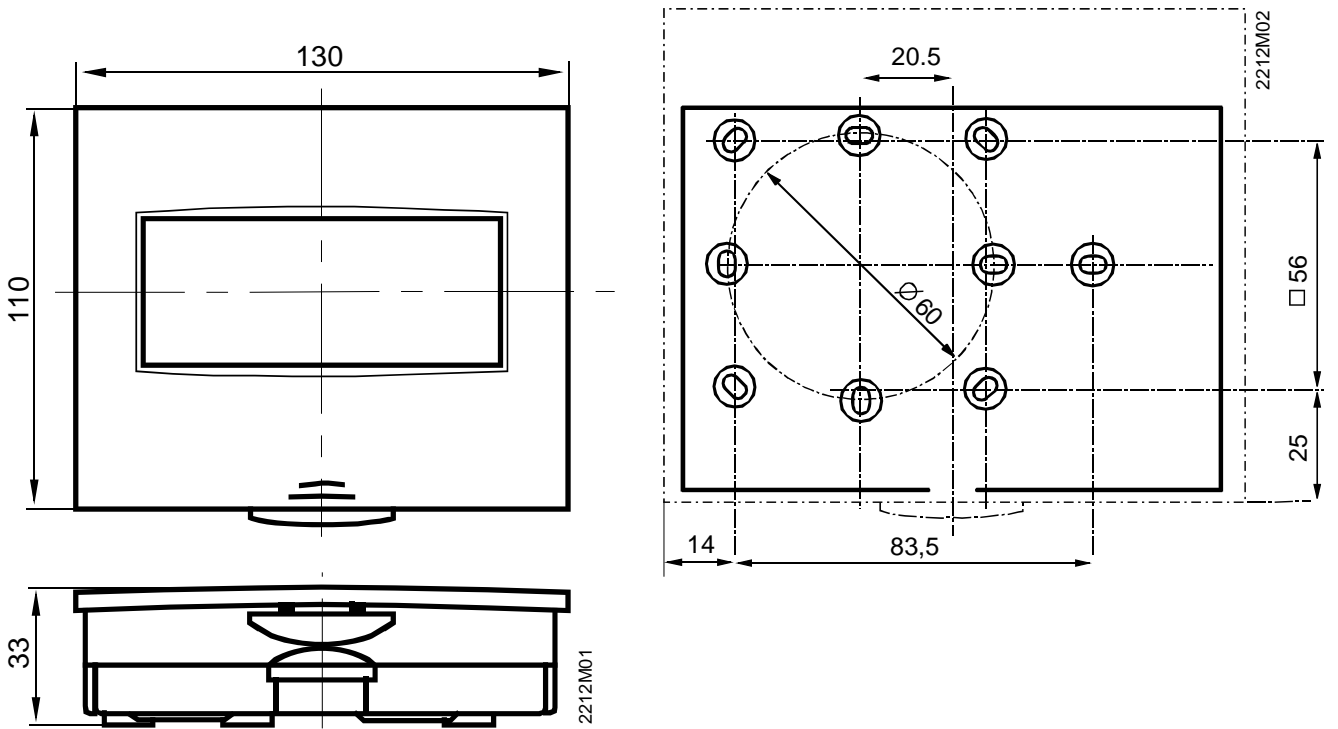

Receiver REV-R...

